

PROFESSIONAL SERIES POWER AMPLIFIERS

PC2602/2602M

OPERATING MANUAL

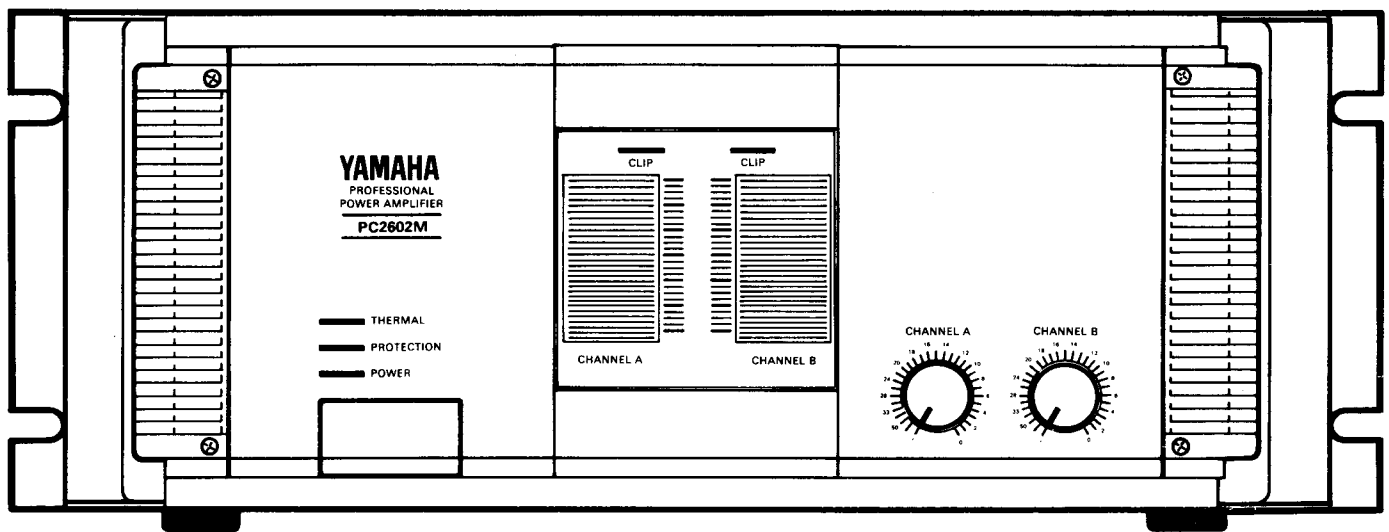

ABOUT THIS MANUAL

SCOPE

The PC2602M is a system oriented amplifier, made to be used in conjunction with mixers, consoles, frequency dividing networks and speakers — those made by Yamaha or by other manufacturers. Like any power amplifier, the PC2602M's performance depends on system design and installation, in addition to its own capabilities. Thus, the PC2602M Operating Manual is system oriented, describing system design parameters and installation techniques, as well as operation and performance of the PC2602M.

ORGANIZATION

We recommend that you read the entire Operating Manual. However, if you are using the PC2602M in an existing system, and you are familiar with high power amplifiers, the BRIEF OPERATING INSTRUCTIONS, Pages 2 & 3, contain all the information necessary for basic connections and operation.

NOTE: The PC2602 is identical to the PC2602M except there are no Bargraph Type Peak Power Level Meters.

IMPORTANT NOTICE FOR THE UNITED KINGDOM

Connecting the Plug and Cord

IMPORTANT: The wires in this mains lead are coloured in accordance with the following code:

Blue : NEUTRAL

Brown : LIVE

As the colours of the wires in the mains lead of this apparatus may not correspond with the coloured markings identifying the terminals in your plug, proceed as follows:

The wire which is coloured BLUE must be connected to the terminal which is marked with the letter N or coloured BLACK.

The wire which is coloured BROWN must be connected to the terminal which is marked with the letter L or coloured RED.

Making sure that neither core is connected to the earth terminal of the three pin plug.

CONTENTS

INTRODUCTION	1
BRIEF OPERATING INSTRUCTIONS	2
GENERAL SPECIFICATIONS	4
PERFORMANCE GRAPHS	5
PERFORMANCE OSCILLOGRAPHS	6
A DISCUSSION OF SPECIFICATIONS	7
MOUNTING	10
COOLING FAN FILTER MAINTENANCE	11
BLOCK DIAGRAM	11
DIMENSIONS	12

INTRODUCTION

The PC2602M is not just "another big amplifier", it is an exciting new approach to high power sound. Yamaha's leadership is clearly demonstrated by the PC2602M's professional features, sophisticated design, and uncompromising performance.

BARGRAPH TYPE PEAK POWER LEVEL METERS*

Instead of the more common and slow responding VU meters, the PC2602M has LCD PEAK READING METERS that accurately display a full 26 lines of output level. The peak meters have large, illuminated faces marked with watts into 8 ohms. The fast responding meters provide a better way to see the program dynamics and transient power demands placed on the system, and the available headroom.

By indicating headroom, the meters help the operator avoid over-driving the system, thereby preventing the "clipped" waveforms so dangerous to drivers and loudspeakers.

CALIBRATED INPUT ATTENUATORS

The PC2602M has decibel-calibrated INPUT ATTENUATORS to complement its peak reading meters. The input attenuators are marked in 31 calibrated steps, detented for extra accuracy. The attenuators provide a smooth, noise free transition from the highest to the lowest audio level. dB-calibrated input attenuators have numerous advantages: on the road, they allow predictable and repeatable setups; in commercial sound applications, they allow easy, accurate input sensitivity adjustments; in studios or discos, they let operators simultaneously adjust the level of two channels (or two programs on separate amplifiers) with precise tracking.

INPUT AND OUTPUT CONNECTIONS

INPUT CONNECTORS for each channel include one "male" and one "female" XLR connector plus two parallel phone jacks. This provides the flexibility necessary for convenient bridging to another amplifier, as well as for adapter-free connection to almost any mixer.

MONAURAL OPERATION

The PC2602 and PC2602M can easily be adapted for monaural (BTL) operation by setting the rear-panel MODE switch to MONO. In the MONO mode use the channel A input connectors and channel A attenuator for level control. The "+" terminal of the speaker system is connected to the channel A "+" output terminal and the "-" terminal of the speaker system is connected to the channel B "+" output terminal. Leave the channel A and B "-" output (SPEAKER) terminals and channel B input terminals unconnected.

SPEAKER IMPEDANCE IS 8 — 32 OHMS FOR MONO MODE OPERATION (US & GENERAL MODEL).

SPEAKER IMPEDANCE IS 16-32 OHMS FOR MONO MODE OPERATION (CANADIAN MODEL).

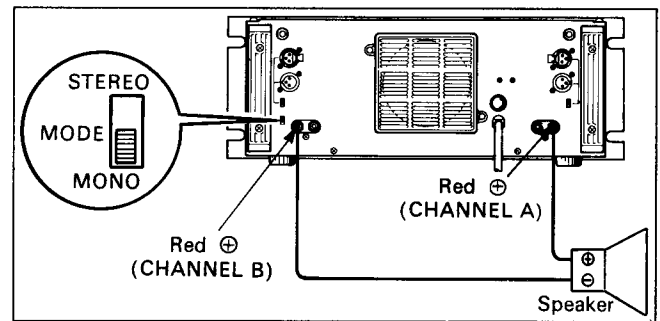

Fig. 1

PERFORMANCE

The PC2602M's performance is as impressive as its features. At a sustained output of 260 watts into 8 ohms (for each channel), there is plenty of punch to reproduce the powerful peaks essential to clean studio monitoring. High power handling also makes the PC2602M an unbeatable choice for live rock or disco sound systems, where an amplifier can really "cook" all night long. Power alone is no virtue; the PC2602M has ultra-low distortion, less than 0.007% THD at full rated power — the kind of low distortion that is undetectable by even the most critical listeners.

A high damping factor of better than 250 at 1 kHz reduces the tendency for speaker cone overshoot, giving tighter and better defined bass response. On the other hand, the PC2602M's frequency response extends well beyond 50 kHz, enabling it to accurately reproduce the most complex musical waveforms — even the tortuous output of today's synthesizers. However, high frequency response has not been achieved at the expense of stability; in fact, the PC2602M is rock steady. Even when connected to highly reactive multi-speaker loads, there is no tendency to shut down or "take off" into spurious oscillation.

MECHANICAL CONSIDERATIONS

The PC2602M is constructed to withstand the high "G" forces encountered on the road. Its solid front panel mounts in any standard 19-inch rack, and, for a large amplifier, the PC2602M weighs a modest 57 pounds (26 kg). Front panel controls and meters are recessed to avoid damage or accidental setting changes, and are further protected by a pair of sturdy carrying handles. Inside and out, the PC2602M is extremely reliable. Still, should service ever be required, the unit is designed for easy access. The forced cooling fan is driven when the heat sink exceeds 60 degrees Centigrade. Four non-conductive feet ensure proper air flow when the amplifier is shelf mounted, and avoid inadvertent ground loops. Multiple protection circuits make the amplifier nearly abuse proof and eliminate the need for troublesome DC power supply fuses.

* The PC2602 does not have the Bargraph Type Peak Power Level Meters.

BRIEF OPERATING INSTRUCTIONS

Front Panel

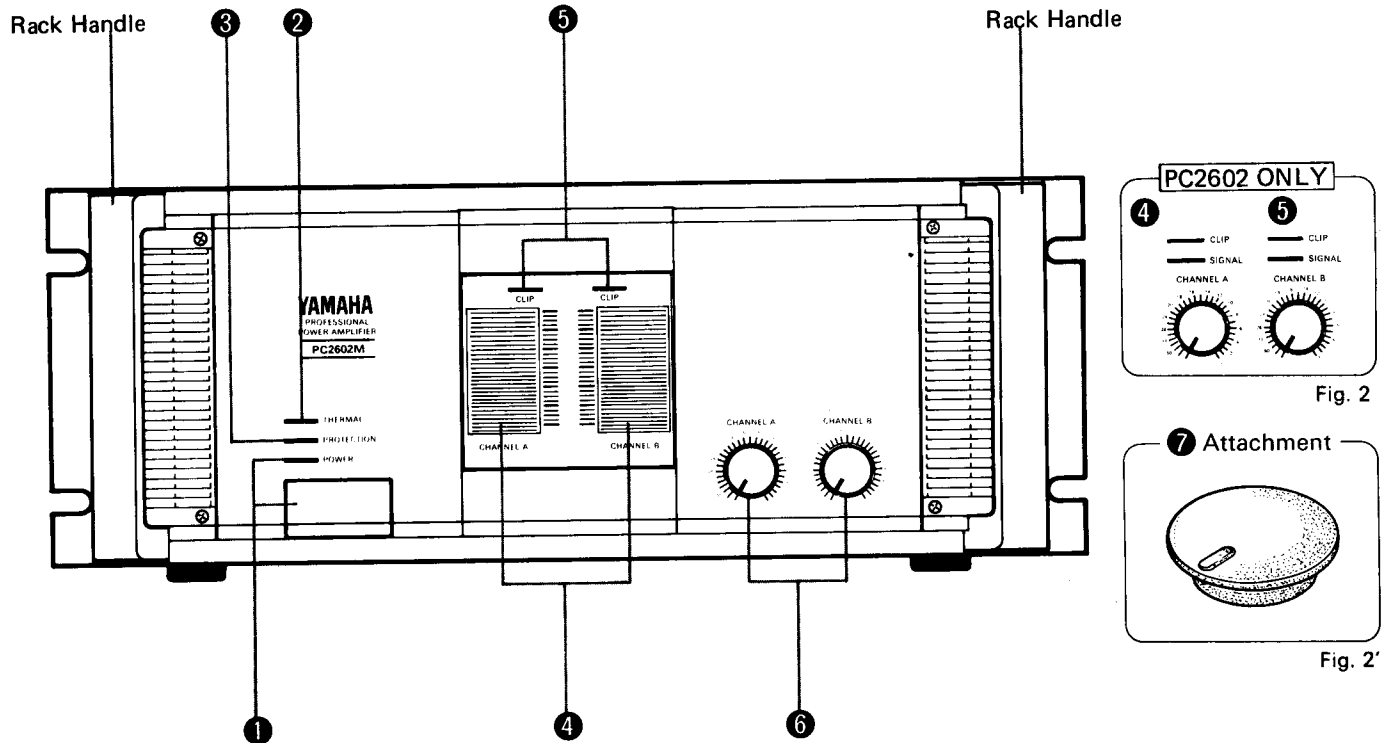

① POWER Switch/POWER Indicator (Red)

Pressing this switch turns power to the amplifier ON and causes the power indicator to light. Pressing the POWER switch a second time turns the unit. OFF.

② THERMAL Indicator (Red)

This indicator lights when the forced cooling fan is operating.

③ PROTECTION Indicator (Red)

Lights for approximately 6 ± 2 seconds after power is switched on, indicating that the protection circuitry is active. The speaker outputs are shut off while this indicator is lit. If the protection circuitry is activated for any reason during amplifier operation, the indicator will light and the speaker outputs will be shut off. Once the cause of protection activation has been remedied normal operation will resume automatically and the protection indicator will go out.

④ Bargraph Type Peak Power Level Meters (PC2602M ONLY)

The logarithmic meter scales read directly in watts when speaker impedance is 8 ohms. There are 26 segments for output level on these illuminated meters.

④ SIGNAL Indicators (Green) (PC2602 ONLY)

The SIGNAL indicators light when output level of the signals is 2 V or more, in the range of 20 Hz to 20 kHz, for confirmation of input signal.

⑤ CLIP Indicators

The CLIP indicators light when output distortion of the respective channel exceeds approximately 1%. This indicates that the amplifier is clipping due to excessive input signal levels.

⑥ Input Attenuators

These attenuators adjust the sensitivity of the respective amplifier channel in 31 steps. Attenuation in the fully clockwise position is 0 dB, and ∞ in the fully counter-clockwise position.

⑦ Knob Lock Adaptors (Supplied)

The Knob Lock Adaptors prevent accidental alteration of attenuator settings once the appropriate settings have initially been made. How to install Knob Lock Adaptors: pull out the Input Attenuator Knob to insert the Knob Lock Adaptors into exactly the same place.

BRIEF OPERATING INSTRUCTIONS

Rear Panel

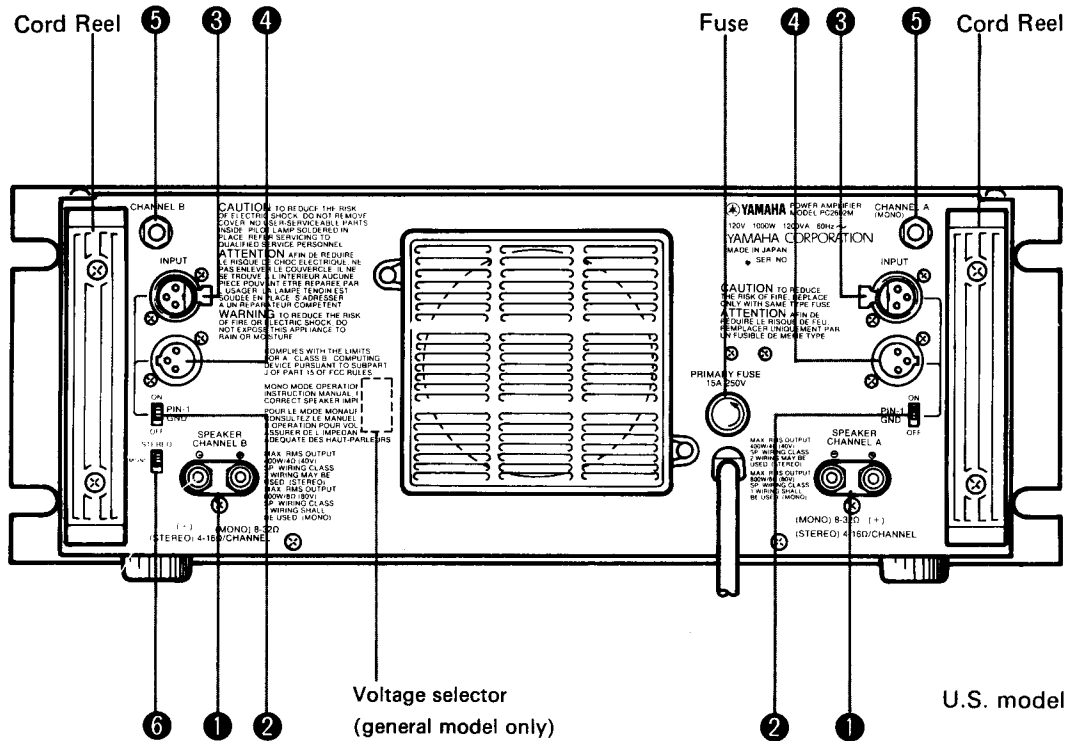

1 SPEAKER Output Terminals

The red SPEAKER terminal is connected to the "+" input terminal of the speaker system used and the black SPEAKER terminal is connected to the "-" speaker input terminal.

2 PIN 1 GND SW

Couples or decouples the INPUT connectors earth line (pin 1, shield). Normally ON. In some cases where ground loops cause excessive hum, turning the ground switch OFF can interrupt the loop and reduce the hum.

3 INPUT Connectors (XLR-3-31)

These connectors are generally used as inputs. Pin 1 is shield, pin 2 is hot and pin 3 is cold. Compatible connectors include Canon XLR-3-12C and Switchcraft 5C-1055A.

4 INPUT Connectors (XLR-3-32)

Compatible with Canon XLR-3-11C or Switchcraft 5C-1056A connectors, these connectors are useful for sending the input signal to other power amplifiers.

5 Phone Jacks

These jacks accept balanced input via TRS phone plugs.

6 MODE Selector Switch

Determines whether the amplifier is to operate in the stereo or mono (BTL) mode.

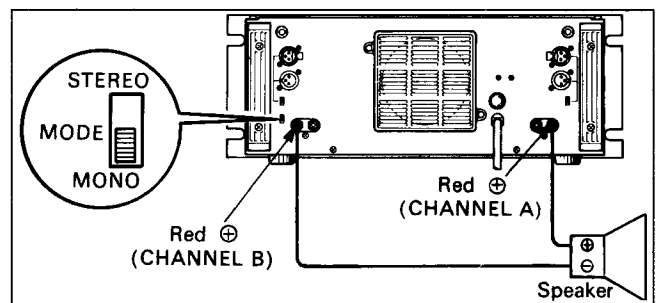

MONAURAL OPERATION

The PC2602M can easily be adapted for monaural (BTL) operation by setting the rear-panel MODE switch to MONO. In the MONO mode use the channel A input connectors and channel A attenuator for level control. The "+" terminal of the speaker system is connected to the channel A "+" output terminal and the "-" terminal of the speaker system is connected to the channel B "+" output terminal. Leave the channel A and B "-" output (SPEAKER) terminals and channel B input terminals unconnected.

GENERAL SPECIFICATIONS

POWER OUTPUT LEVEL

Continuous average sine wave power with less than 0.05% THD. 20 Hz to 20 kHz.

Stereo, 8 ohms 260 W + 260 W
Stereo, 4 ohms 400 W + 400 W
Mono, 8 ohms 800 W

FREQUENCY RESPONSE

10 Hz to 50 kHz, 8 ohms, 1 W 0 ± 1 dB

TOTAL HARMONIC DISTORTION

Stereo 8 ohms, 130 W
20 Hz to 20kHz Less than 0.007%
Stereo 4 ohms 200 W
20 Hz to 20 kHz Less than 0.015%
Mono 8 ohms 400 W
20 Hz to 20 kHz Less than 0.015%

INTER MODULATION DISTORTION

250 Hz 12.5 kHz mixed 4 : 1
Stereo 8 ohms, 130 W Less than 0.005%
Mono 8 ohms, 400 W Less than 0.007%

INPUT SENSITIVITY

Input level which produces 260 W output into 8 ohms
..... +4 dB (1.23 V rms)

INPUT IMPEDANCE

Balanced and unbalanced inputs maximum attenuator setting 15 kohms

DAMPING FACTOR

$f=1$ kHz, $RL=8 \Omega$ Greater than 250

S/N RATIO

Input shorted @ 12.7 kHz 107 dB
Input shorted @ IHF-A 110 dB

SLEW RATE

Stereo 8 ohms ± 55 V/ μ sec Full Swing
Mono 16 ohms ± 110 V/ μ sec Full Swing

CHANNEL SEPARATION

8 ohms 130 W
20 Hz to 20 kHz 85 dB

INDICATORS

PILOT RED LED
Protection (Muting ON) RED LED
Thermal RED LED
Clipping (1% THD) RED LED
Peak Power Meters
(PC2602M only) Illuminated LCD 26 segments
Signal GREEN LED (PC2602 only)

FRONT PANEL CONTROLS

Power switch Push-ON/Push-OFF
Input attenuators (one per channel) 31 positions

REAR PANEL CONTROLS

Mode switch STEREO/MONO
Pin 1 GND switch ON/OFF
Voltage selector switch (general model only)

PROTECTION CIRCUITS

Muting 6 ± 2 seconds after power turned ON
DC sense DC ± 2 V output voltage
Ultra-low frequency 20 V p-p $f=1$ Hz
($P_o=6.2$ W, $RL=8$ ohms)
Thermal $\geq 85^\circ\text{C}$ heat sink temp.
PC limiter $RL \leq 1.0 \Omega$

COOLING FAN CIRCUIT

Fan ON/OFF TH $\geq 60^\circ\text{C}$ ON (TH; heat sink temp.)
TH $\leq 45^\circ\text{C}$ OFF

POWER REQUIREMENTS

U.S. & CANADIAN models AC 120 V, 60 Hz
GENERAL model AC 220/240 V, 50/60 Hz

POWER CONSUMPTION

U.S. model 1300 W
CANADIAN model 1000 W, 1200 VA
GENERAL model 1000 W

DIMENSIONS

(W x D x H) 480 x 431.3 x 184 mm
(18-7/8" x 17" x 7-1/4")

WEIGHT

..... 26 kg (57 lbs)

ATTACHMENT

..... Knob Lock Adaptor x 2

NOTE: CANADIAN models must be operated into 8 ohms in stereo mode and 16 ohms in mono mode in accordance with safety regulations.

All specifications subject to change without notice.

PERFORMANCE GRAPHS

FREQUENCY RESPONSE
 LOAD : 8 ohms
 Po = 1 W at 1kHz
 MODE : STEREO
 Input balanced

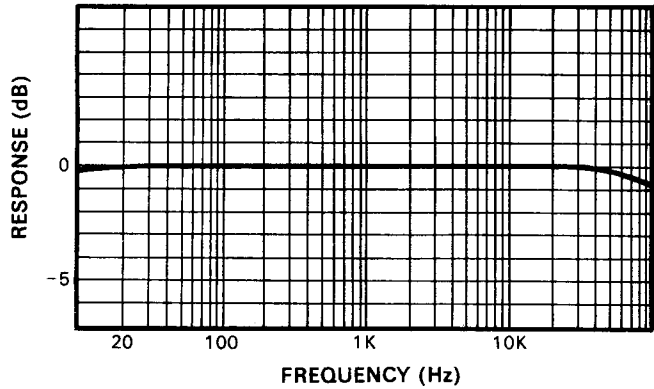

Fig. 3

POWER BAND WIDTH
 THD : 0.05%
 LOAD : 8 ohms
 MODE : STEREO
 Both channels driven

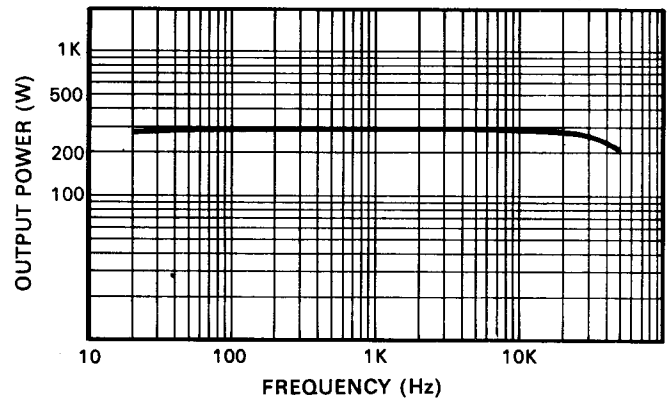

Fig. 6

T.H. DISTORTION
 LOAD : 16 ohms
 MODE : MONO
 Unbalanced input

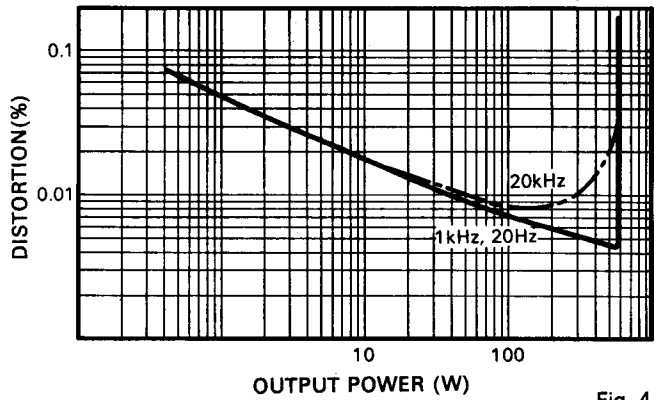

Fig. 4

DAMPING FACTOR
 LOAD : 8 ohms
 MODE : STEREO

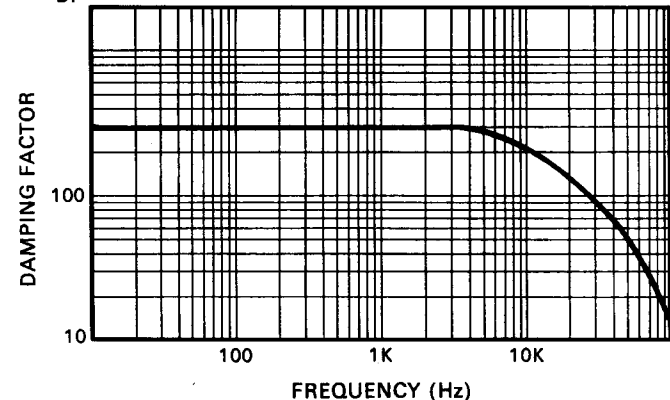

Fig. 7

T.H. DISTORTION
 LOAD : 8 ohms
 MODE : STEREO
 Both channels driven

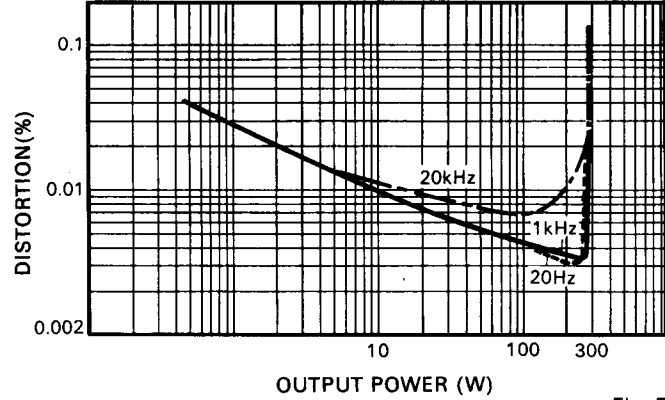

Fig. 5

PERFORMANCE OSCILLOGRAPHS

20Hz SQUARE-WAVE RESPONSE

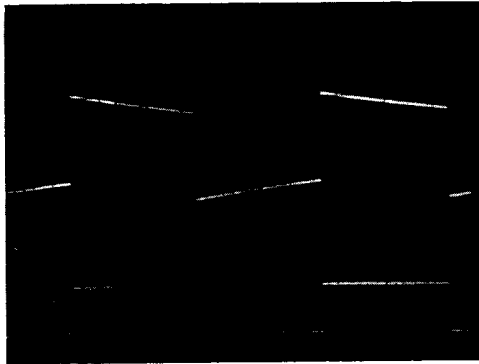
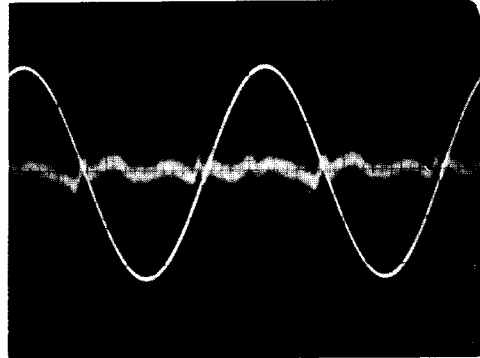

Fig. 8

TOTAL HARMONIC DISTORTION WITH A 20kHz SINE WAVE



LOAD : 8 Ω
MODE : STEREO
Po = 130 W
Fig. 12

1kHz SQUARE-WAVE RESPONSE

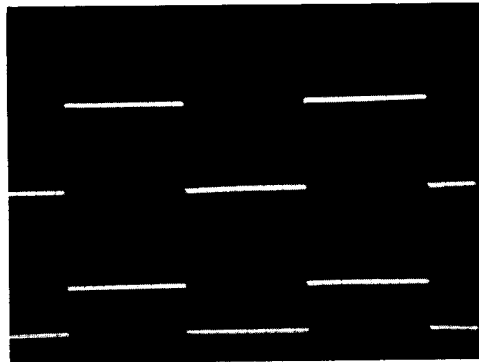

20V/1μs
Fig. 9

SLEW RATE

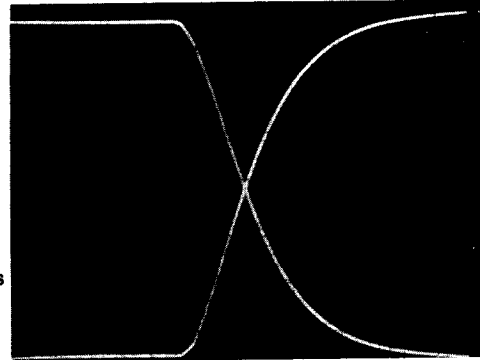

Fig. 13

20kHz SQUARE-WAVE RESPONSE

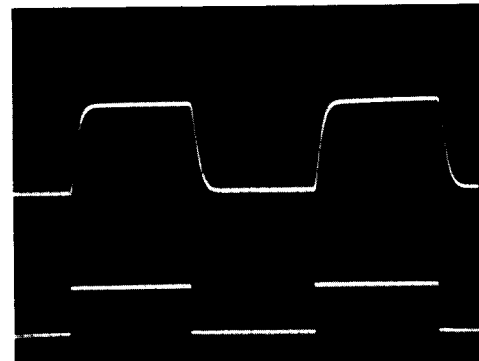

Fig. 10
0.5V/1μs

RISE TIME

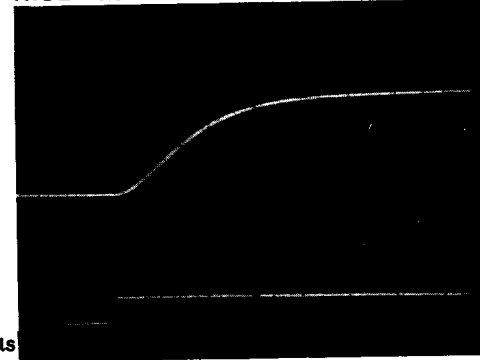
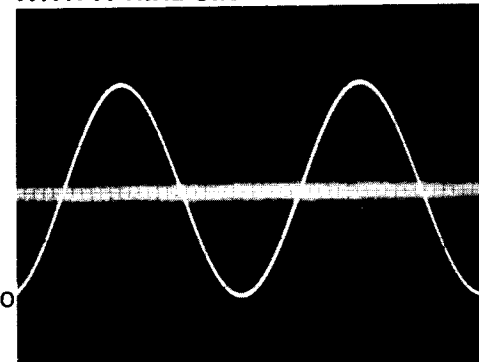

Fig. 14

TOTAL HARMONIC DISTORTION WITH A 1kHz SINE WAVE



LOAD : 8 Ω
MODE : STEREO
Po = 130 W

Fig. 11

- In each photo, output waveform is upper and input waveform is lower.
- Horizontal and vertical scales in each photo are optional. But the scales in the photo of rise time are 0.5V/Div (vertical) and 1μsec/Div (horizontal).
- MODE STEREO LOAD 8 ohms.

A DISCUSSION OF SPECIFICATIONS

POWER OUTPUT

Types of Power Ratings

Peak Power refers to the maximum undistorted power output of an amplifier. Most amplifiers cannot sustain their peak power ratings for long periods of time without external cooling fans. Because there are many different methods of rating an amplifier's peak power, it is hard to objectively compare the peak power ratings of two amplifiers. The peak power rating is primarily useful for determining an amplifier's ability to reproduce the peaks and transients in a musical program, peaks which may be 20 dB or more above the average power level. The ability to accurately reproduce these high power peaks in a musical program is one of the most important advantages of the PC2602M as compared to a smaller power amplifier.

"RMS" power is actually a misnomer for *average power*. Average power is usually measured with a sine wave input signal, and is equal to the amplifier's RMS power*. While it means the same as "RMS power", to be more accurate, the PC2602M is rated in watts of "continuous average sine wave power".

Since the PC2602M is a *professional* power amplifier, not sold for home hi-fi use, it is not required to meet the power rating standard set by the FTC (Federal Trade Commission), a standard meant for *consumer* power amplifiers. However, the PC2602M is measured under severe conditions which simulate the most demanding *professional* usage. Thus, the PC2602M would easily meet the FTC ratings for consumer amplifiers. In addition, the PC2602M user has the benefits of professional features and reliability.

Reasons for a High Power Amplifier

An interesting characteristic of the human ear is described by the "Weber-Fechner" law. In its general form, the law applies to all our senses:

The amount of additional stimulus needed to produce a perceptible change is dependent on the amount of stimulus already present.

In mathematical terms, the Weber-Fechner law suggests that the human ear responds to changes in sound level in a logarithmic manner. More simply this means that *for a sound to seem twice as loud*, it requires approximately *ten times as much acoustic power* (and therefore ten times as much amplifier power). Thus, the PC2602M's high power output capabilities are extremely valuable.

One of the other benefits of high power output is the ability of the amplifier to easily reproduce high peak power transients (which may be 100 times the average program power, or even more).

DISTORTION

The PC2602M is designed to have the lowest possible distortion. There are many different forms of distortion, however, and comprehensive distortion ratings offer a means to compare the performance of different amplifiers.

Harmonic distortion, is characterized by the appearance at the amplifier output of harmonics of the input waveform which were not present in the original input waveform. *Total Harmonic Distortion*, or T.H.D., is the sum total of all of these unwanted harmonics expressed as a percentage of the total signal.

Harmonic distortion, in an amplifier can be created in any of several ways. The T.H.D. rating of a power amplifier refers to creation of unwanted harmonics by the amplifier during "linear" operation (normal input and output levels, impedances, etc.). Harmonic distortion is also created by "clipping", a form of "non-linear" operation, which occurs when the signal level at an amplifier's input is high enough to drive the amplifier beyond its rated maximum output. The amplifier, in attempting to reproduce this signal, reaches its maximum output voltage swing before it reproduces the top of the signal waveforms. Since the output voltage cannot rise any farther, the tops of the waveform are "squared off", or clipped. Clipping distortion adds odd upper harmonics (3rd harmonic, 5th, etc.) to the original signal. (Input clipping would be similar, where the input stage of the amplifier is overdriven by a high level input signal.) The PC2602M has wide input headroom and extremely high peak power output capabilities (headroom) to help avoid the problems of clipping distortion.

Another form of harmonic distortion that occurs in some power amplifiers is called *crossover distortion*. * Crossover distortion can be caused by improper bias in the output transistors of an amplifier. The *amount* of crossover distortion stays the same whether the signal is large or small, so the *percentage* of distortion goes down as the signal level goes up. Thus, an amplifier with crossover distortion may sound relatively distortion free at high output levels, yet sound "fuzzy" at low levels. Some amplifiers have internal adjustments which enable a service technician to control the amount of output transistor bias, and therefore control the distortion.

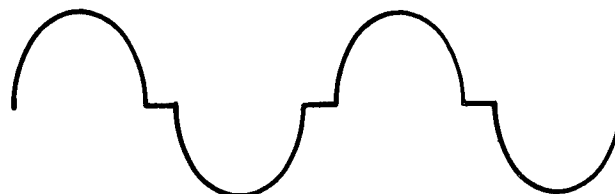

Fig. 15A — Large Amplitude Sine Wave with Crossover (notch) Distortion.



Fig. 15B — Smaller Amplitude Sine Wave with Same Amount (higher %) of Crossover (notch) Distortion.

*"Crossover", in this case, refers to the transition between the positive half and the negative half of the output voltage waveform in a "push-pull" class B or AB power amplifier; it has nothing to do with the crossover used to divide frequencies in a speaker system.

Intermodulation Distortion, or **I.M.**, is characterized by the appearance in the output waveform of frequencies that are equal to sums and differences of integral multiples of two or more of the frequencies present in the input signal. The difference between intermodulation distortion and harmonic distortion is that two or more different frequencies must be present to produce intermodulation distortion (only one frequency is needed for harmonic distortion to appear), and that intermodulation distortion products may not be harmonically related to the original frequencies. Like its harmonic distortion figure, the intermodulation distortion in the PC2602M is low enough to be virtually inaudible even in the most critical situations.

FREQUENCY RESPONSE

The *frequency response* of the PC2602M describes the variation in its output signal level with frequency when the input signal is held constant. The extremely "flat" frequency response curve of the PC2602M is an indication of its overall quality and its ability to respond to upper and lower harmonics of signals all the way to the extremes of the audio spectrum.

Because extreme stability is necessary for some types of commercial sound applications, some manufacturers restrict frequency response or allow relatively high distortion in return for increased amplifier stability. The PC2602M, on the other hand, has excellent frequency response and ultralow distortion, yet is inherently stable under the most difficult loads, even in the "mono" mode.

The frequency response of the PC2602M has been intentionally limited, however, at very low frequencies (sub-audio). Because of this, severe low frequency transients, or DC offset, appearing at the input to the PC2602M are unlikely to damage a speaker load. Other amplifiers which are DC coupled throughout may have a "flatter" sub-audio frequency response, but this makes them capable of amplifying dangerous DC input voltage or sub-audio transients and delivering them (at high power) to a speaker.

POWER BANDWIDTH

The *power bandwidth* of the PC2602M is a measure of its ability to produce high power output over a wide frequency range. The limits of the power bandwidth are those points where the PC2602M can only produce 1/2 the power that it can produce at 1000Hz. While the frequency response is measured at relatively low power output (1 watt), the power bandwidth is measured at the PC2602M's full power output (before clipping). The power bandwidth of the PC2602M is quite "flat", and extends to 100kHz, well beyond the limits of the audio spectrum.

The wide power bandwidth of the PC2602M means that it can reproduce high level upper harmonics of a signal as easily as it can reproduce mid-range fundamentals. It means that you get full power performance from the PC2602M over the entire audio frequency spectrum. This is especially important when the amplifier is called upon to reproduce musical material with high energy over a wide frequency range, such as rock.

CHANNEL SEPARATION

This specification indicates the output from one channel when a signal is fed to the other channel. The PC2602M's channel separation is very good, which means that even critical stereo programs will be unaffected by crosstalk between channels.

HUM AND NOISE

Hum or noise from a power amplifier disrupts a program, and is irritating to a listener. Hum and noise could be considered a form of distortion. The PC2602M's hum and noise are so low that they are completely inaudible under any normal listening circumstances.

SLEW RATE

Slew rate is a measure of a power amplifier's ability to follow a fast rising waveform at higher frequencies and higher power outputs than the rise time measurement.

It might seem reasonable to assume that the fastest slew rate for an audio waveform occurs at 20kHz. However, this is not the case. When one frequency is superimposed upon another, the combined waveform has a slew rate that is greater than the slew rate of either signal by itself. The actual value of the slew rate of one of these waveforms (or any waveform) depends not only on the frequency, but on the amplitude of the waveform as well. Thus, the criteria for a good slew, rate specification, which indicates that an amplifier can reproduce these combination waveforms, vary with the maximum power output capability of the amplifier. The higher the power, the higher the required slew rate. With a 55 volts/microsecond slew rate, the PC2602M can easily reproduce even the most extreme audio waveforms at its full power output.

INPUT IMPEDANCE

The *input impedance* of the PC2602M is high enough to allow it to be used with most semi-pro devices, or to be used as a "bridging" load for a 600-ohm source.

INPUT SENSITIVITY

The PC2602M's *input sensitivity* indicates the input drive voltage needed for the PC2602M to produce its rated output of 260 watts into 8 ohms (input attenuators are adjusted to maximum clockwise rotation for minimum attenuation).

PROTECTION CIRCUITS AND THERMAL SPECIFICATIONS

The PC2602M is one of the safest amplifiers you can find. It incorporates multiple protection circuits—transient suppression, current limiting, short circuit and overload protection, DC offset sensing with relay disconnect, heat sink overtemperature sensing with auto shutdown — to prevent speaker damage in the event of an amplifier failure, and to prevent amplifier damage in the event of a load or cable problem. Because the circuits function automatically, front panel LEDs are installed to inform the operator of overload protection status. A thermal LED also warns of excessive heat sink temperature.

GAIN

Gain is the ratio of the PC2602M's output voltage to its input voltage. Maximum gain occurs when the input attenuators are set for minimum attenuation. If the input and output voltage are specified in dB, the voltage gain is equal to the difference of the two dB numbers. As stated under INPUT SENSITIVITY, an input voltage of +4 dB (1.23 volts) produces an output power of 260 watts into an 8-ohm load.

OUTPUT IMPEDANCE

The *output impedance* of the PC2602M is extremely low. Thus, within its operating limits, the PC2602M is a good approximation of a perfect voltage source and will deliver increasing power levels into lower impedance loads in a linear fashion according to Ohm's law.

DAMPING FACTOR

Damping factor is a term that is derived by dividing the load impedance (speaker or other load) by the amplifier's output impedance. Thus, a high damping factor indicates a low output impedance at a specified load.

The cone/voice-coil assembly of a loudspeaker gains inertia during its back and forth movements. This inertia can cause it to "overshoot", that is, to continue movement in one direction, even when the amplifier is trying to pull it back to the other direction. An amplifier with a low output impedance can "damp" (reduce) unwanted loudspeaker motions, as explained below.

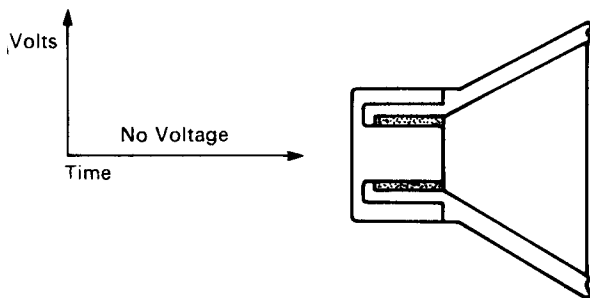

Fig. 16A — Speaker Cone at Rest

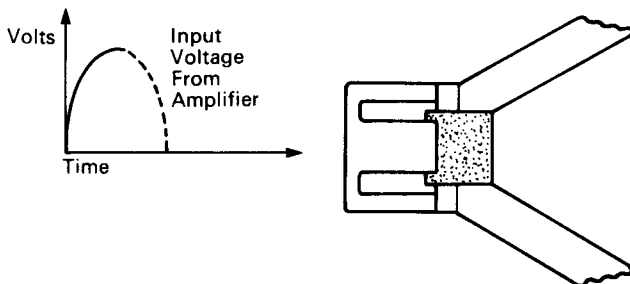

Fig. 16B — Speaker Cone Moved Outward by Positive-Going Voltage from Amplifier.

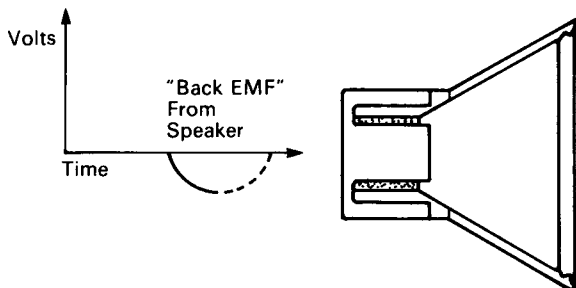

Fig. 16C — Voltage from amplifier has dropped to zero but speaker cone has moved back PAST its rest position (overshoot) and is producing a voltage of its own: "Back EMF".

During the "overshoot" movement, the voice coil of the loudspeaker interacts with the loudspeaker's magnetic assembly to produce a voltage called "back E.M.F." (electro-motive force). This action is similar to the operation of a dynamic microphone. If the amplifier's output impedance is low, this "back E.M.F." voltage is shunted through the amplifier's output circuits to ground, and back to the voice coil. Since the path from the voice coil, through the amplifier's output circuits, and back to the voice coil is a complete circuit, a current flows in the voice coil. This current causes the voice coil to act like an electro-magnet; the electro-magnet (voice coil) interacts with the magnetic assembly of the loudspeaker, and the unwanted overshoot is reduced (a magnetic braking action).

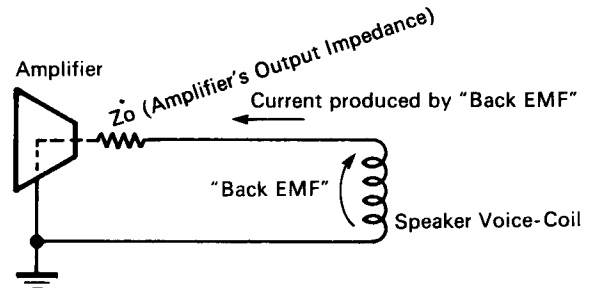

Fig. 17 — Current produced by "Back EMF" follows path through amplifier's output impedance to speaker-coil.

If the amplifier's output impedance is low (considerably less than the impedance of the loudspeaker voice coil), this damping action is limited only by the resistance of the voice coil combined with the resistance of the speaker lead wires. While the value of a high damping factor in reducing cone overshoot is disputed, the PC2602M's high damping factor is evidence of good overall engineering design.

MOUNTING

Shelf Mounting

The PC2602M can be used on any flat, level surface as long as there is adequate ventilation. Do not remove the amplifier's feet as this would block airflow through the bottom panel.

Permanent-installation Rack Mounting

The PC2602M can be mounted in any standard 19" electronic equipment rack. The rear panel of the rack should be left open to promote smooth airflow. Cooling fans are required for rack-mounted PC2602M's, if they must produce extremely high average power output (i.e. stereo operation into 4-ohm loads or mono operation into an 8-ohm load). Refer to the diagrams to the right for the ideal cooling fan configuration.

* **One unit of PC2602 (M) demands one cooling fan unit.**

Portable Rack Mounting

Road cases must be durable enough to withstand rough handling and airline travel. Secure the back end of the PC2602M side panels to the rack with the screws provided, and provide cooling fans (like those shown to the right) if ventilation is restricted.

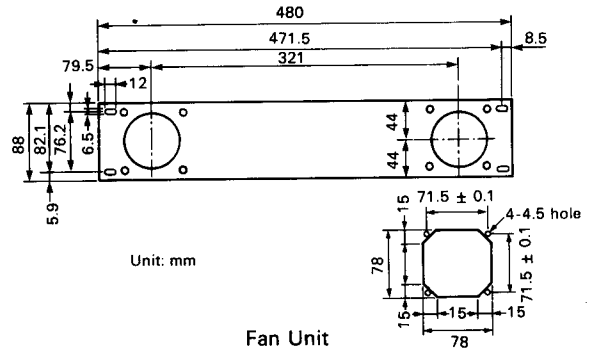
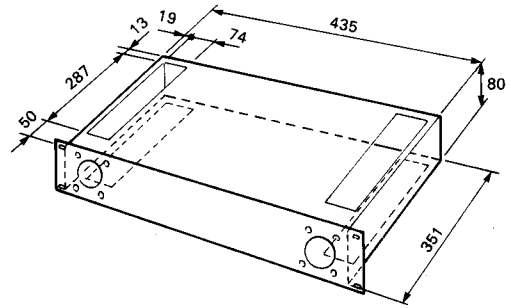

Fan Unit

CAUTION!

If unit(s) are to be used in a rack mounted installation, it is recommended that fan cooling be installed. Without fan cooling, units could be damaged from excessive temperature conditions.

The minimum required airflow rate for fans should be 2 x 19 cubic feet per minute (CFM). Use only fans with the above specification.

The following are some examples of fans with the proper specifications:

Manufacturer	Type/Model	Airflow Rate
ORIENTAL MOTOR CO LTD	MU825S-23 or equivalent	19 CFM

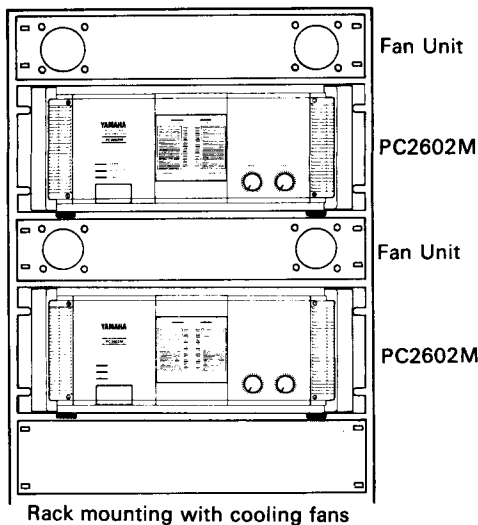
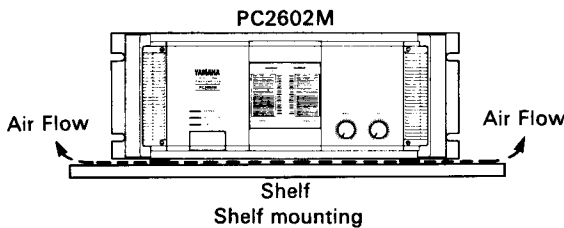

Fan Unit

* The fan unit shown uses two fans, each with a maximum volume of 19 CFM (cubic feet per minute) and a maximum pressure of 5 mm H₂O.

* Slits should be provided on the top and bottom sides for air circulation.

Side Panel Support Screws

Use the both screw holes on each side panel. Use only the supplied screws (millimeter thread).

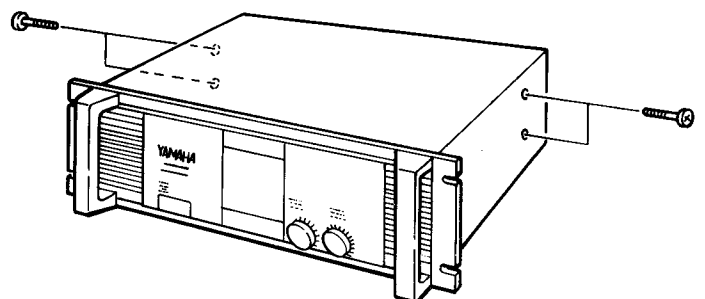

COOLING FAN FILTER MAINTENANCE

The filter element is removed and cleaned as follows.

1. Remove the two upper screws on the rear panel with a 3 mm Allen (hex) wrench.
Remove the filter cover.
2. Remove filter element and wash with plain water.
Detergent may also be used if the filter is exceptionally dirty.
3. Dry the filter thoroughly. NEVER REPLACE THE FILTER WHILE IT IS WET!
4. Replace the filter element and filter cover.

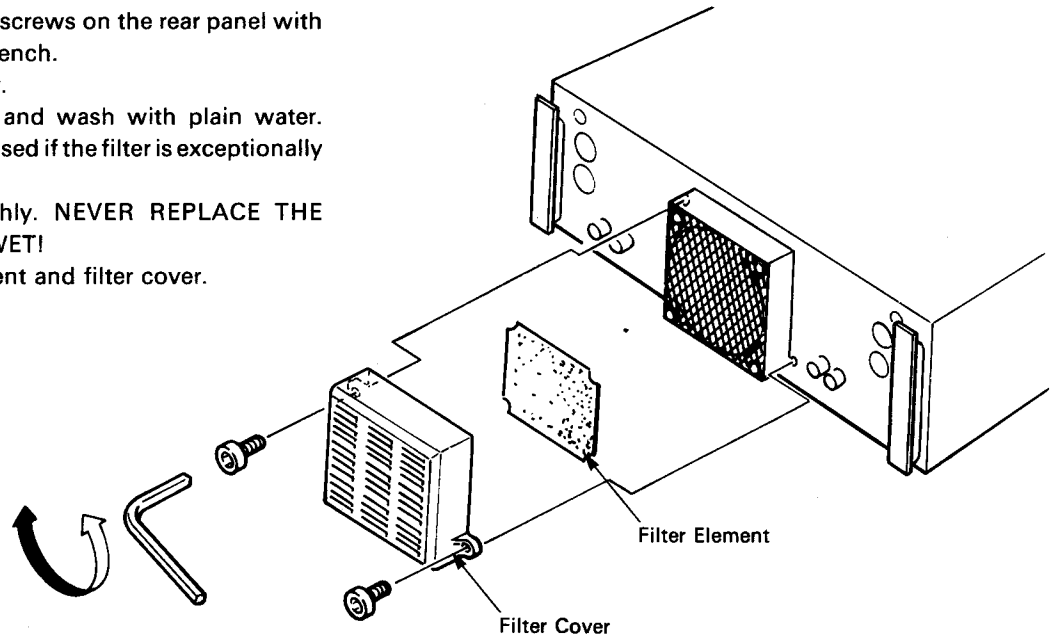

BLOCK DIAGRAM

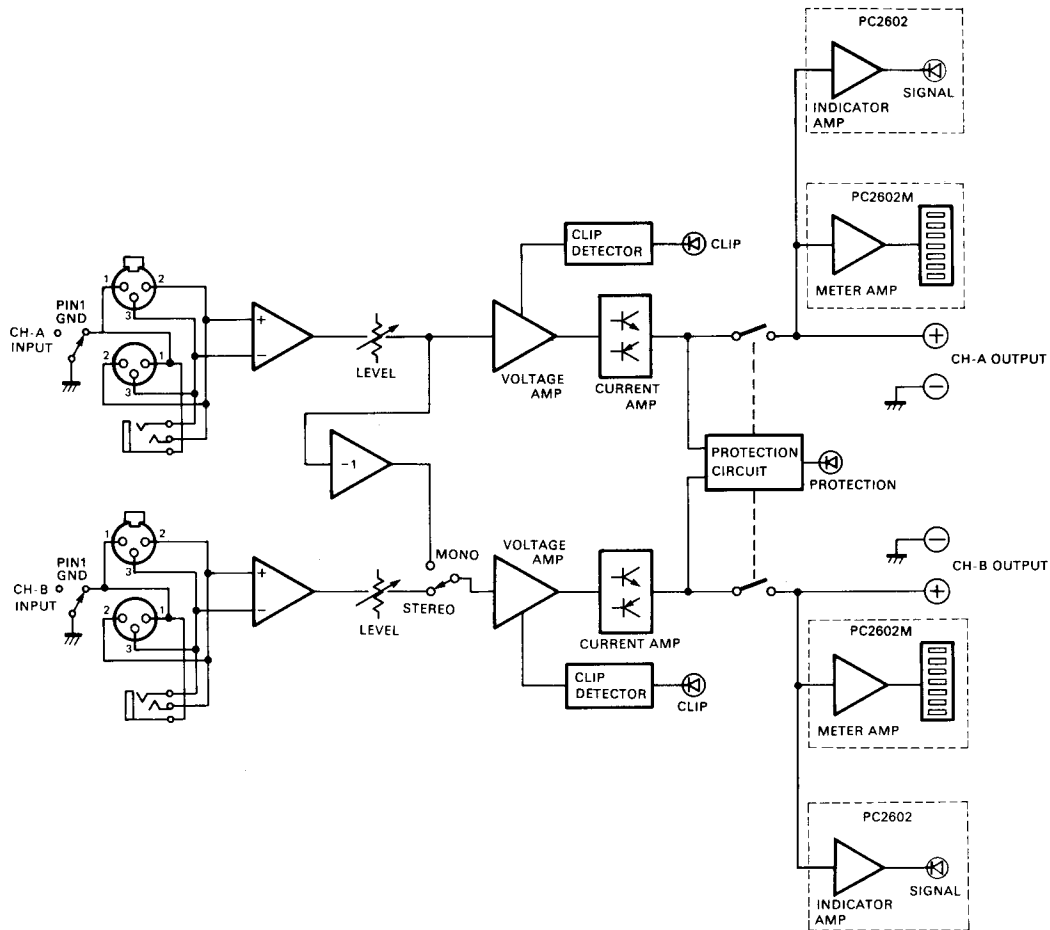

DIMENSIONS

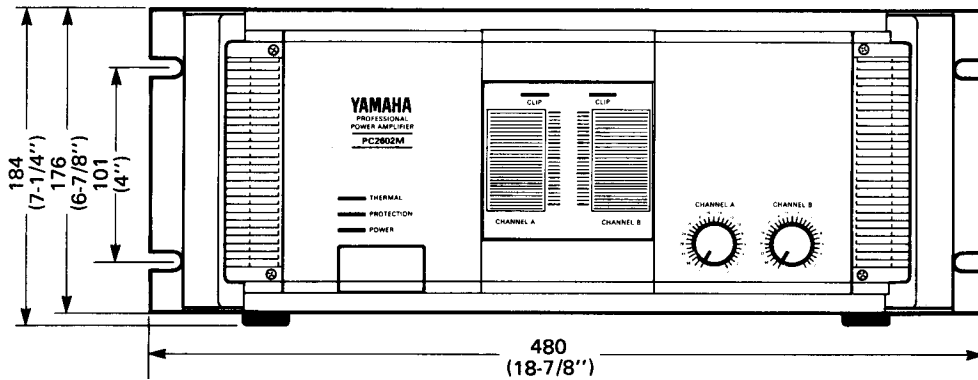
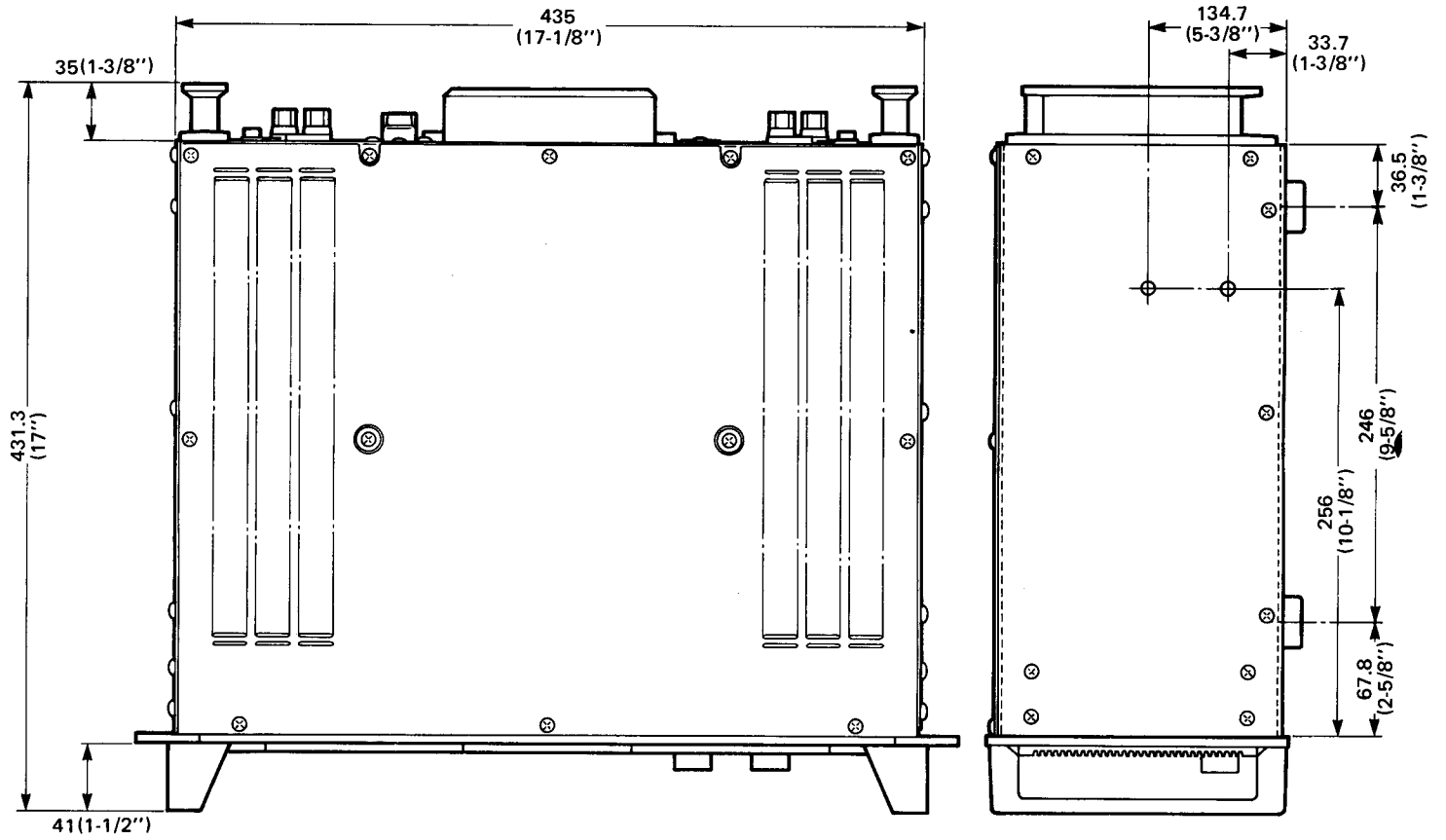

Unit: mm (inch)

SERVICE

The PC2602, PC2602M are supported by Yamaha's worldwide network of factory trained and qualified dealer service personnel. In the event of a problem, contact your nearest Yamaha dealer.

YAMAHA

YAMAHA CORPORATION
P.O.Box 1, Hamamatsu, Japan